

DA-5

PIR Detector for Automatic Door Control

**Visonic**

Installation Instructions

1. INTRODUCTION

The DA-5 is a PIR motion detector designed for use with access control and automatic door opening systems. It can be installed at various heights on the wall above the door (Figure 1) or on the ceiling (Figure 2), with its detection pattern directed at the floor in front of the door. Upon detection of motion, the on-board changeover relay energizes for a predetermined period. The relay pull-in time is adjustable between 1 and 60 seconds with an on-board timer control.

Operating power for the DA-5 may be supplied from a 12 or 24V AC or DC source. A jumper is provided on the printed circuit board for selecting the input voltage.

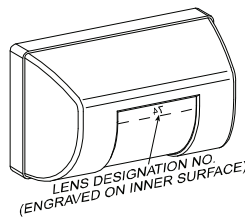

Figure 1. Wall Mount Configuration

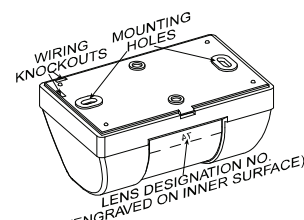

Figure 2. Ceiling Mount Configuration

2. SPECIFICATIONS

OPTICAL

Detection Lens: Lens No. 74.

Detection Zones: 3 zones (A, B and C). 7 beams per zone.

ELECTRICAL

Input Voltage: 12/24VAC/DC (protected against reverse polarity)

Current Drain: 7 mA standby, 50 mA max @ 12 VDC; 14 mA standby, 65 mA max @ 12 VAC

7 mA standby, 50 mA max. @ 24 VDC; 15 mA standby, 80 mA max. @ 24 VAC

Output Relay Pull-in Period: 3 to 60 seconds, adjustable.

Relay Switching Capability: 2 A max. at 28 V AC or DC.

Detector Type: Dual-element pyroelectric sensor.

MOUNTING

Alternatives: Wall or ceiling mounting above the door. Surface mountable on top of a standard single-gang electrical switchbox.

Height: 2.15 - 3 m (7 - 10 ft)

ENVIRONMENTAL

Operating Temperature: -10°C to 50°C (14°F to 122°F)

Storage Temperature: -20°C to 60°C (-4°F to 140°F)

Intended Use: Indoors or in water/rain-protected outdoor areas.

PHYSICAL

Size: 105 x 65 x 53 mm (4-1/10 x 2-1/2 x 2-1/10 in.).

Weight: 95 g (3.3 oz).

Color: White.

3. INSTALLATION

3.1 Construction Details

A. General Data

The unit consists of a plastic base to which the electronic module is fastened, and a cover assembly with a curved surface to which the milky white lens is attached. The cover must be removed for:

- Installation and wiring
- Adjusting the timer
- Selecting the input voltage
- Inverting the lens for ceiling installation.

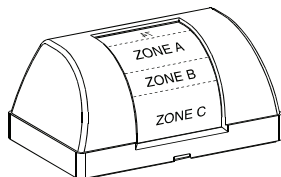

Figure 3. Lens Division into Detection Zones

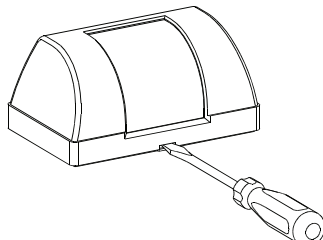

Figure 4. Removing the Cover

B. Lens Description

The DA-5 uses lens No. 74 that has 3 arrays of lens segments (Fig 3). Each array provides a detection zone, and all 3 zones combine to form the entire detection pattern (see Figures 5 thru 8).

Any detection zone or lens segment may be masked (para. 3.8). The lens is factory set as required for wall mounting, but may be easily inverted for ceiling mounting (para. 3.3).

C. Cover Removal

To separate the cover from the base, insert a screwdriver blade into the slot provided between the cover and the base. Twist the screwdriver slightly or move the handle down. The cover will swing outward, ready for removal by hand.

3.2 Detection Patterns

A. Over-the-Door Wall Mounting

The DA-5 may be wall-mounted at various heights above the door, centered with respect to the doorframe. Increasing the mounting height will cause the coverage pattern to expand, as demonstrated in figures 5 - 8. Note that detection zones B and C partially overlap.

B. Ceiling Mounting

If the DA-5 is mounted on the ceiling, the detection patterns will resemble those obtained with the unit mounted at the corresponding height on the wall.

3.3 Ceiling Installation

Ceiling mounting requires the lens be inverted in its window. The lens is held in place by a flexible plastic retainer. The lens number DE1704

(74) is engraved on the inner grooved surface of the lens near the top rim (see Figure 9).

To invert the lens, proceed as follows:

- Hold the cover assembly in the palm of your hand.
- Seize the flat extractor tab (part of the lens retainer) between two fingers of your other hand.
- Press the extractor tab slightly down and pull it toward the opposite side of the cover. This will dislodge the lens retainer, which can then be removed.
- Push the lens carefully out. Invert it (180° rotation) and place it again in the lens window. The lens number should now be near the 4 small plastic stoppers. Verify that the lens is snug against the lens window frame.
- Insert the straight, smooth edge of the lens retainer into the deep end of the lens window. Then press the extractor tab down until the near edge of the lens retainer snaps into place.

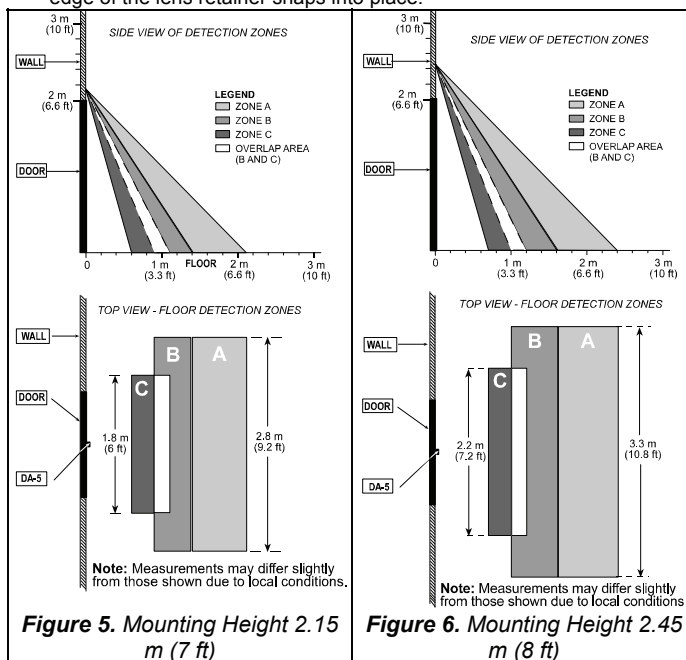

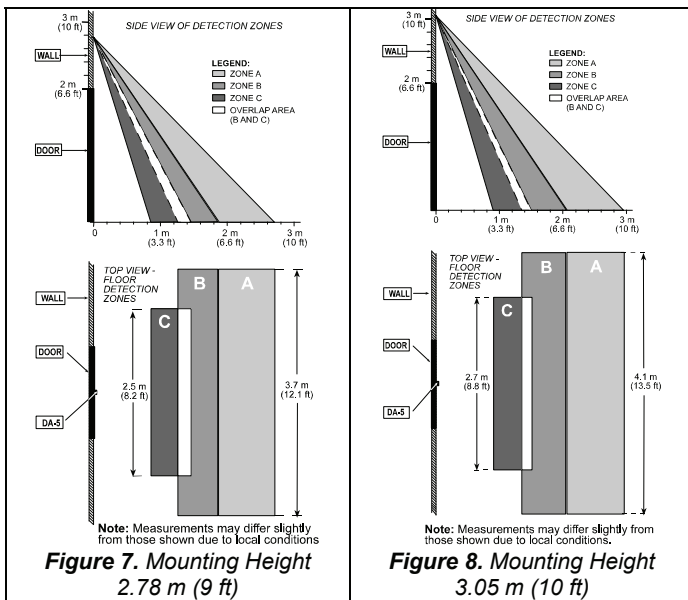

3.5 Wiring

The wiring configuration depends on the door control circuit in use. The output relay contacts of the DA-5 can switch currents up to 2A at 28 VAC or DC. Refer to Fig. 11 and connect as follows:

- A. Wire the output relay's C and N.O. (or C and N.C.) contacts to switch the door control device on and off, as required for the door control circuit in use.

Warning! Verify that the input voltage jumper is positioned correctly. For 12V operation, install it across the two pins. If the power source is 24 V, remove the jumper and install it on a single pin to prevent it from getting lost.

- B. Connect the power supply leads to the 12/24 V (+) and (-) terminals. The unit accepts both AC and DC inputs. When using an AC supply, disregard the (+) and (-) markings.

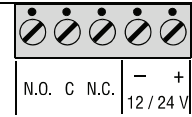

Figure 11. Terminal Block.

- C. Seal all wire entry holes with RTV (clear silicone sealant) to prevent insects and air currents from entering the unit.

3.6 Timer Adjustment

The relay timer is adjustable from 3 seconds to 1 minute, as required for triggering the door control mechanism. Rotate the knob towards MIN to decrease the relay pull-in time, and towards MAX to increase the relay pull in time. The results of your adjustment can be verified by watching the on-board LED, which will be lit as long as the output relay is energized.

Note: For an accurate timer adjustment test, the cover must be installed.

3.7 Testing

- A. Mount the cover by pushing it onto the base until it snaps into place with a click.
- B. Apply power to the DA-5 and wait 5 minutes for the unit to warm up and stabilize before testing.
- C. Test the DA-5 by walking towards the door through the detector's field of view. Verify that the LED lights and the relay pulls in each time the detection pattern is crossed. If operation is erratic, readjust the timer control of the DA-5.
- D. If the coverage pattern is too far from the door, you can mask the farthest beam array (para. 3.8).

3.8 Beam Masking

Ordinary opaque masking tape can be used to mask individual lens segments of any one of the three detection zones, or an entire zone (Fig. 3). The masking tape will prevent the infrared energy from reaching the sensor through the blocked segment.

Cut a masking tape patch that fits the dimensions of the lens area you wish to block. Apply it accurately to the inner (grooved) surface of the appropriate segment(s). In some cases, more than one layer of the masking tape may be required to completely block the infrared energy.

W.E.E.E. Product Recycling Declaration
For information regarding the recycling of this product you must contact the company from which you originally purchased it. If you are discarding this product and not returning it for repair then you must ensure that it is returned as identified by your supplier. This product is not to be thrown away with everyday waste.
Directive 2002/96/EC Waste Electrical and Electronic Equipment.

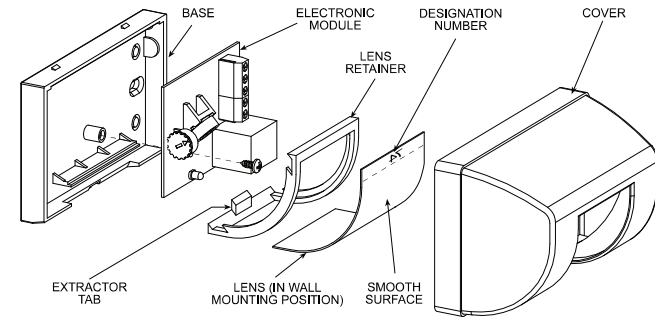

Figure 9. DA-5 Exploded View

3.4 Installation

The DA-5 is suitable for indoor or water/rain protected outdoor installations. The minimum height for wall installation is 2.15 m (7 ft) slightly above the door frame's center. Remove the DA-5 cover (para. 3.1C). Two elongated holes are available in the base for wall mounting (Fig. 10).

Note: The spacing between the mounting holes permits installation of the DA-5 on a standard single-gang electrical switchbox.

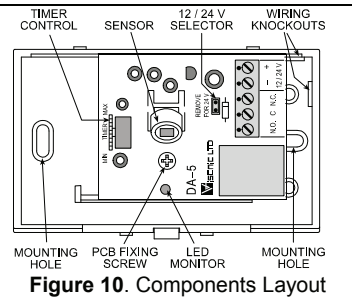

Figure 10. Components Layout

WARRANTY

Visonic Limited (the "Manufacturer") warrants this product only (the "Product") to the original purchaser only (the "Purchaser") against defective workmanship and materials under normal use of the Product for a period of twelve (12) months from the date of shipment by the Manufacturer.

This Warranty is absolutely conditional upon the Product having been properly installed, maintained and operated under conditions of normal use in accordance with the Manufacturers recommended installation and operation instructions. Products which have become defective for any other reason, according to the Manufacturers discretion, such as improper installation, failure to follow recommended installation and operational instructions, neglect, willful damage, misuse or vandalism, accidental damage, alteration or tampering, or repair by anyone other than the manufacturer, are not covered by this Warranty.

The Manufacturer does not represent that this Product may not be compromised and/or circumvented or that the Product will prevent any death and/or personal injury and/or damage to property resulting from burglary, robbery, fire or otherwise, or that the Product will in all cases provide adequate warning or protection. The Product, properly installed and maintained, only reduces the risk of such events without warning and it is not a guarantee or insurance that such events will not occur.

THIS WARRANTY IS EXCLUSIVE AND EXPRESSLY IN LIEU OF ALL OTHER WARRANTIES, OBLIGATIONS OR LIABILITIES, WHETHER WRITTEN, ORAL, EXPRESS OR IMPLIED, INCLUDING ANY WARRANTY OF MERCHANTABILITY OR FITNESS FOR A PARTICULAR PURPOSE, OR OTHERWISE. IN NO CASE SHALL THE MANUFACTURER BE LIABLE TO ANYONE FOR ANY CONSEQUENTIAL OR INCIDENTAL DAMAGES FOR BREACH OF THIS WARRANTY OR ANY OTHER WARRANTIES WHATSOEVER, AS AFORESAID.

THE MANUFACTURER SHALL IN NO EVENT BE LIABLE FOR ANY SPECIAL, INDIRECT, INCIDENTAL, CONSEQUENTIAL OR PUNITIVE DAMAGES OR FOR LOSS, DAMAGE, OR EXPENSE, INCLUDING LOSS OF USE, PROFITS, REVENUE, OR GOODWILL, DIRECTLY OR INDIRECTLY ARISING FROM PURCHASER'S USE OR INABILITY TO USE THE PRODUCT, OR FOR LOSS OR DESTRUCTION OF OTHER PROPERTY OR FROM ANY OTHER CAUSE, EVEN IF MANUFACTURER HAS BEEN ADVISED OF THE POSSIBILITY OF SUCH DAMAGE.

THE MANUFACTURER SHALL HAVE NO LIABILITY FOR ANY DEATH, PERSONAL AND/OR BODILY INJURY AND/OR DAMAGE TO PROPERTY OR OTHER LOSS WHETHER DIRECT, INDIRECT, INCIDENTAL, CONSEQUENTIAL OR OTHERWISE, BASED ON A CLAIM THAT THE PRODUCT FAILED TO FUNCTION.

However, if the Manufacturer is held liable, whether directly or indirectly, for any loss or damage arising under this limited warranty, **THE MANUFACTURER'S MAXIMUM LIABILITY (IF ANY) SHALL NOT IN ANY CASE EXCEED THE PURCHASE PRICE OF THE PRODUCT**, which shall be fixed as liquidated damages and not as a penalty, and shall be the complete and exclusive remedy against the Manufacturer.

When accepting the delivery of the Product, the Purchaser agrees to the said conditions of sale and warranty and he recognizes having been informed of.

Some jurisdictions do not allow the exclusion or limitation of incidental or consequential damages, so these limitations may not apply under certain circumstances.

The Manufacturer shall be under no liability whatsoever arising out of the corruption and/or malfunctioning of any telecommunication or electronic equipment or any programs.

The Manufacturers obligations under this Warranty are limited solely to repair and/or replace at the Manufacturer's discretion any Product or part thereof that may prove defective. Any repair and/or replacement shall not extend the original Warranty period. The Manufacturer shall not be responsible for dismantling and/or reinstallation costs. To exercise this Warranty the Product must be returned to the Manufacturer freight pre-paid and insured. All freight and insurance costs are the responsibility of the Purchaser and are not included in this Warranty.

This warranty shall not be modified, varied or extended, and the Manufacturer does not authorize any person to act on its behalf in the modification, variation or extension of this warranty. This warranty shall apply to the Product only. All products, accessories or attachments of others used in conjunction with the Product, including batteries, shall be covered solely by their own warranty, if any. The Manufacturer shall not be liable for any damage or loss whatsoever, whether directly, indirectly, incidentally, consequentially or otherwise, caused by the malfunction of the Product due to products, accessories, or attachments of others, including batteries, used in conjunction with the Products. This Warranty is exclusive to the original Purchaser and is not assignable.

This Warranty is in addition to and does not affect your legal rights. Any provision in this warranty which is contrary to the Law in the state or country where the Product is supplied shall not apply.

Warning: The user must follow the Manufacturer's installation and operational instructions including testing the Product and its whole system at least once a week and to take all necessary precautions for his/her safety and the protection of his/her property.

1/08



VISONIC LTD. (ISRAEL): P.O.B 22020 TEL-AVIV 61220 ISRAEL. PHONE: (972-3) 645-6789, FAX: (972-3) 645-6788

VISONIC INC. (U.S.A.): 65 WEST DUDLEY TOWN ROAD, BLOOMFIELD CT. 06002-1376. PHONE: (860) 243-0833, (800) 223-0020 FAX: (860) 242-8094

VISONIC LTD. (UK): FRASER ROAD, PRIORY BUSINESS PARK, BEDFORD MK44 3WH. PHONE: (0870) 7300800 FAX: (0870) 7300801

INTERNET: www.visonic.com

©VISONIC LTD. 2008 DA-5 DE1704- (REV. 3, 12/08)



MADE IN ISRAEL